



Brivis

Ducted Reverse Cycle Inverter

Wired Programmable Controller OWNERS MANUAL

For all your Sales and Service enquiries call us on **1300 BRIVIS** (1300 274 847)

www.brivis.com.au

Brivis Australia

61 Malcolm Rd
Braeside Victoria 3195

Australia
1300 BRIVIS (1300 274 847)
Fax: +61 (03) 9264 9400
www.brivis.com.au
email: sales@brivis.com.au

Brivis New Zealand

Distributor: Warm Air Ltd
69 Marsden Street
Lower Hutt 5010 New Zealand
PO Box 38523
Wellington Mail Centre
Wellington 5043 New Zealand
0800 WARMAIR (0800 9276 247)
Ph: +64 (04) 920 1670
Fax: +64(04) 920 1681
www.warmair.co.nz
email: sales@warmair.co.nz

Brivis South Africa

Distributor: Lorenz and Associates
Northlands Deco Park
Cnr Witkoppen and Newmarket Roads
North Riding, Johannesburg South Africa 2194
0861 BRIVIS (0861 274 847)
Ph: +27 (011) 704 6112
Fax: +27 (011) 704 0022
www.brivis.co.za
email: info@brivis.co.za

**PLEASE READ THESE INSTRUCTIONS CAREFULLY BEFORE
INSTALLING & USING THIS PRODUCT**

© 2013 Brivis Climate Systems Pty. Ltd.

All rights reserved. No part of these documents may be used in any way or form without prior written consent from Brivis Climate Systems Pty Ltd.

Part Number: B061526
November 2013
Brivis Climate Systems Pty. Ltd.
ABN 64 096 079 088
AU24752



Specifications subject to change without notice. © 2013 Brivis Climate Systems Pty. Ltd.





- This manual provides detailed descriptions of precautions that should be brought to your attention during operation.
- In order to ensure correct service of the wired control, B026004, please read this manual carefully before using the unit.
- For convenience and for future reference, please keep this manual in a safe place after reading it.
- Due to our policy of continuous improvement, product details and specifications are subject to change without notice.
- This appliance is not intended for use by persons (including children) with reduced physical, sensory or mental capabilities, or lack of knowledge, unless they have been given supervision or instruction concerning the use of the appliance by a person responsible for their safety.
- Children should be supervised to ensure that they do not play with the appliance.

CONTENTS

1. SAFETY PRECAUTIONS.....	1
2. INSTALLATION ACCESSORIES.....	2
3. INSTALLATION METHOD.....	4
4. WIRED PROGRAMMABLE CONTROL WIRING DIAGRAM.....	7
5. SPECIFICATIONS.....	8
6. LCD DISPLAY LAYOUT	9
7. BUTTON DESCRIPTION	10
8. PREPARATORY OPERATION.....	12
9. OPERATION.....	13
10. TIMER FUNCTIONS.....	18
11. WEEKLY TIMER (TIME CLOCK OPERATION).....	21
12. FAULT CODE DEFINITION.....	27

1. SAFETY PRECAUTION

- Read the safety precautions carefully before installing the unit.
- Stated below are important safety issues that must be obeyed.

 WARNING	Means improper handling may lead to personal death or severe injury.
 CAUTION	Means improper handling may lead to personal injury or property loss.

WARNING

Only suitably trained and qualified personnel should install this equipment. Installation by other non-qualified persons will result in a poor installation, and possibly electric malfunction, shock, fire or personal injury. Install this product in strict accordance with this manual. Maintenance, repair or service must be performed by suitably trained and qualified personnel, in accordance with the maintenance instructions improper service or repair may lead to electric shock or fire.

NOTE

- ① Do not install this product adjacent to areas susceptible to flammable gas leaks. If flammable gases leak near the control, it may cause a fire.
- ② Do not operate with wet hands or let water enter the control. Otherwise, electric shock may occur.
- ③ The wiring should be suitably sized for the control current. Incorrectly sized wiring may overheat and cause a fire.
- ④ The specified cables shall be applied in the wiring. Do not allow external forces to pull on the terminals. Damage to the control and overheating may cause a fire.

2. INSTALLATION ACCESSORIES

Select the appropriate installation location

Don't install in an area contaminated with heavy oils, vapors or gases that may cause the control to deform, this may lead to a system malfunction.

Preparation before installation

1. Please confirm that the following parts have been supplied.

No.	Name	Qty.	Remark
1	Wired programmable control	1	Part Number B026004
2	Lithium battery	1	_____
3	Installation & owner's manual	1	_____
4	Connecting wiring loom	1	To connect to the indoor unit

2. Additional field supplied requirements.

No.	Name	Qty.	Remark
1	Phillips screwdriver	1	To mount the control
2	Slotted screwdriver	1	To dismantle the control assembly

2. INSTALLATION ACCESSORIES

Wired programmable control installation precautions.

1. This manual describes the installation method of the control. Please refer to the wiring diagram in this installation manual to wire the control to the indoor unit.
2. The wired control works in a low voltage loop circuit. Do not connect the control directly to mains voltage (240V), or to three phase power (415V) as it will damage the control. Ensure that the control wiring (low voltage loop) and any mains cables are adequately separated.
3. A 6 metre wired control wiring loom is provided with plugs with the wired control.
4. The wired control wiring between the control and the indoor unit can be made longer than the 6 metres provided, but cannot be more than 20 metres in length.

3. INSTALLATION METHOD

Installation diagram

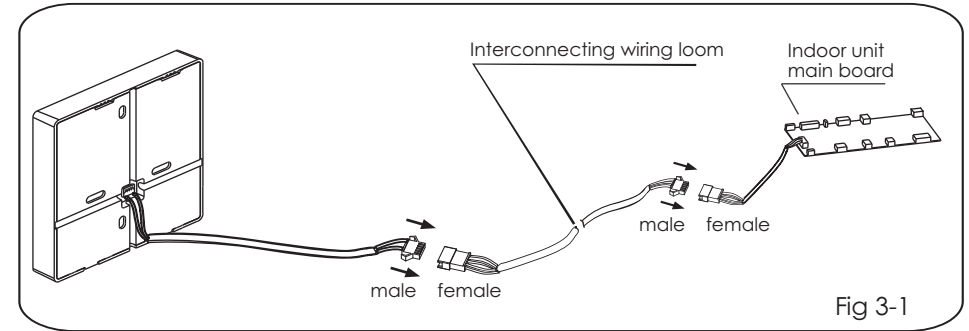

1. Connect the female wiring connector from the indoor unit main board with the male connector of the interconnecting wiring loom. (See Fig.3-1)
2. Connect the other end of the interconnecting wiring loom to the male wiring connector from the wired control. (See Fig.3-1)

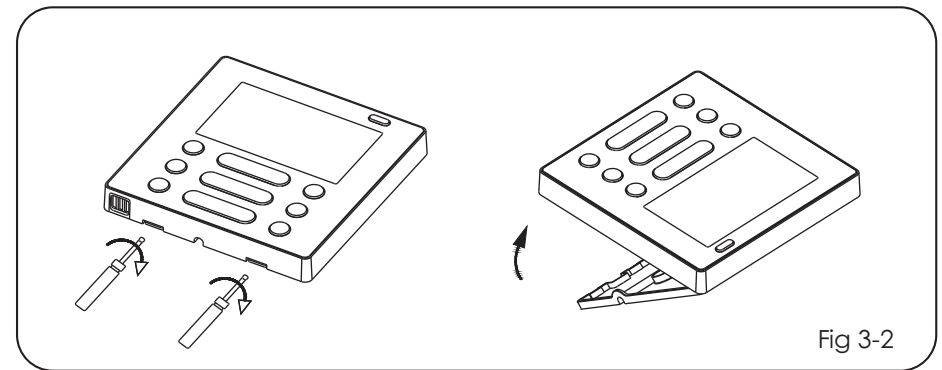

3. Remove the control cover at the bottom with the screwdriver. (See Fig.3-2)

3. INSTALLATION METHOD

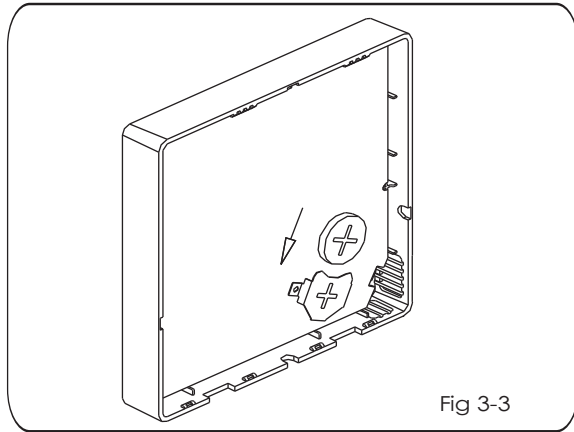

Fig 3-3

4. Install the battery in the rear of the control, make sure the positive side of the battery is correctly aligned on the positive side of the battery connection. (See Fig.3-3)

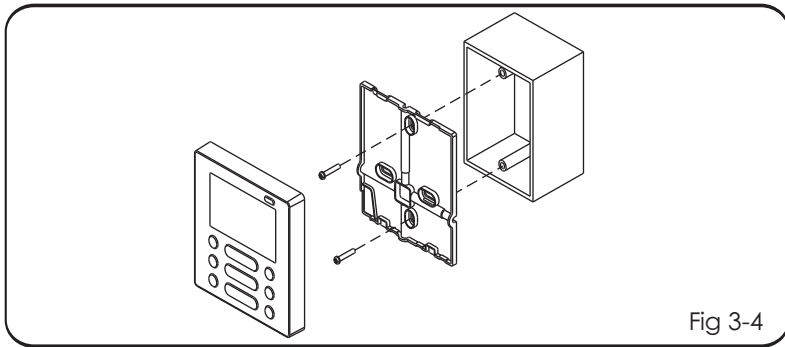

Fig 3-4

5

3. INSTALLATION METHOD

Optional Control extension mounting box

5. Fix the bottom cover to the electric cabinet with the slotted head screws.
Align the bottom cover so it is level on the wall surface, then reinstall the bottom cover of the wall control. (See fig 3-4)



NOTE

Over tightening the mounting screws will damage the control and LCD screen. When installing, please ensure that the screws and wired control are at the same height without protruding and deforming the control LCD screen. When installing, please ensure that there is a small loop of excess cable available to facilitate removal of the control for maintenance service or repair.

6

4 . WIRED PROGRAMMABLE CONTROL WIRING DIAGRAM

1. Wiring diagram of wired control, showing connection with indoor unit
(See fig 4-1)

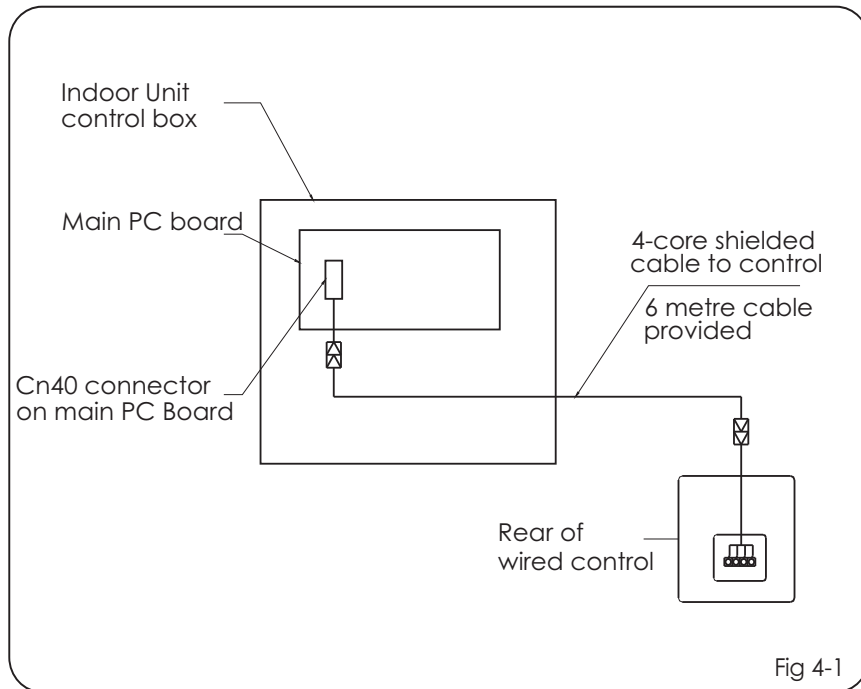

7

5. SPECIFICATION

Operational Limits

Input voltage	DC 12V
Temperature Range	-5 ~ 43°C
Humidity Range	RH 40% ~ RH 90%

The pictures in this manual are diagrammatic for explanation purposes only. The wired control may appear slightly different to that as shown.

8

6. LCD DISPLAY LAYOUT

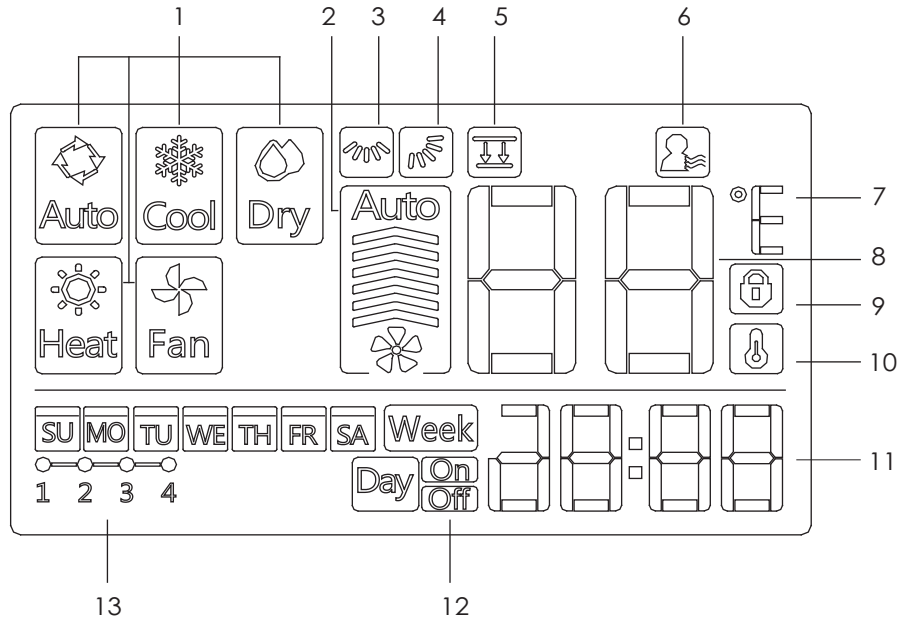

- | | |
|-------------------------------|-------------------------------|
| 1 Operating mode indicator | 8 Temperature display |
| 2 Fan speed indicator | 9 Lock indicator |
| 3 Left-right swing indicator | 10 Room temperature indicator |
| 4 Vertical swing indicator | 11 Clock display |
| 5 Function not applicable | 12 On/Off timer |
| 6 Follow me indicator | 13 Timer display |
| 7 Temperature C°/F° indicator | |

9

7. BUTTON DESCRIPTION

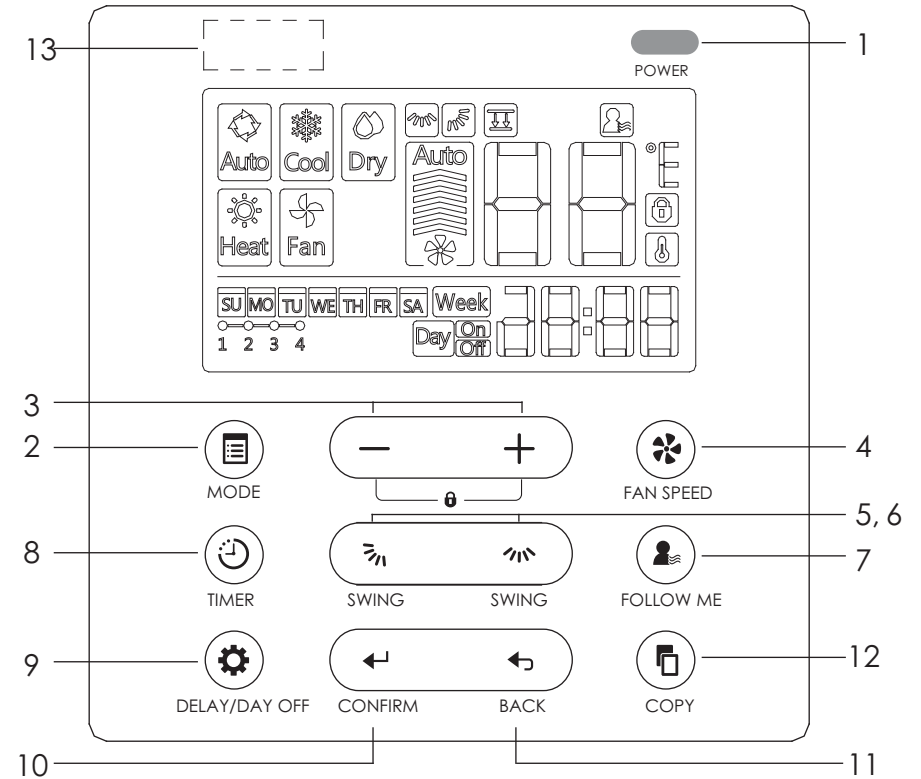

10



7. WIRED CONTROL BUTTON DESCRIPTION

- 2 MODE
- 3 Adjustment up and down
- 4 FAN SPEED
- 5 Vertical airflow direction and swing
- 6 Horizontal swing
- 7 FOLLOW ME
- 8 TIMER
- 9 DELAY/DAY OFF
- 10 CONFIRM
- 11 BACK
- 12 COPY
- 13 Remote receiver (some models)

8. PREPARATORY OPERATION

Set the current day and time

- 1  Press the TIMER button for 3 seconds or more. The timer display will flash.

- 2  Press the "+" or "-" adjust buttons to set the date. The selected date will flash.
- 

- 3  After setting the day and time, press the TIMER button to exit. The control will exit if no buttons are pressed within 10 seconds.

- 4  Press the "+" or "-" adjust buttons to set the current time. Press repeatedly to adjust the time in 1 minute increments. Press and hold to adjust the time rapidly.



ex. Monday AM 11:20

- 5  The setting is complete after pressing TIMER button or if no buttons are pressed within 10 seconds.

9. OPERATION

To start/stop operation

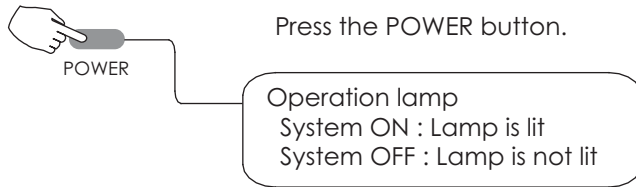

To set the operation mode

Operation mode setting

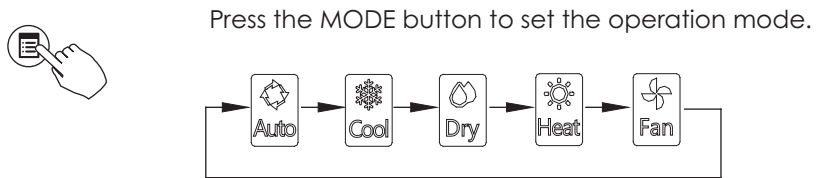

Room temperature setting

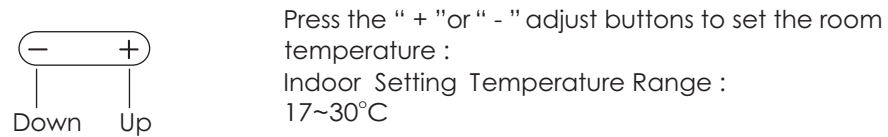

9. OPERATION

Fan speed setting

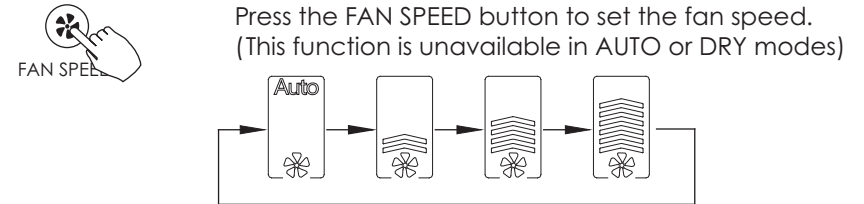

Room temperature sensor selection

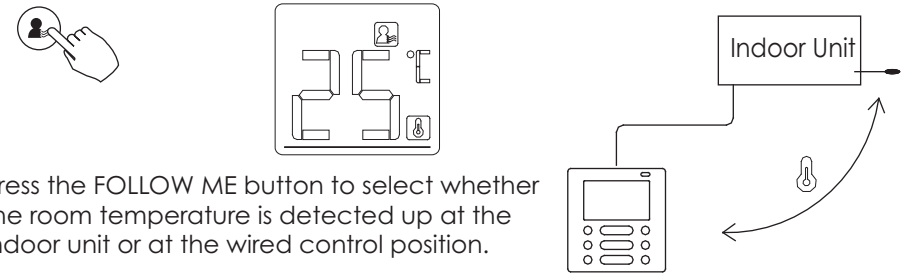

9. OPERATION

Child lock function

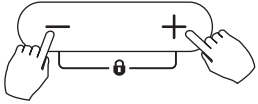

Press the "+" and "-" adjust buttons simultaneously for 3 seconds to activate the child lock function. This will lock all buttons on the wired control. Press the same buttons again for 3 seconds to deactivate the child lock.

When the child lock function is activated, the  indicator appears.

Keypad tone setting



Press the "BACK" and "COPY" button simultaneously for 3 seconds to turn off the keypad tone. Press the same buttons again for 3 seconds to turn on the keypad tone.

°C & °F temperature scale selection

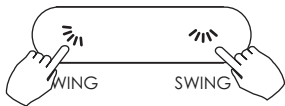



Press and hold  and  buttons together for 3 seconds will alternate the temperature display between the °C and °F

9. OPERATION

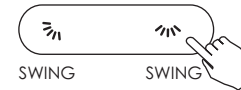
Left-Right swing (applicable products)





Press the  button to start Left-Right swing function. Press the  button again to stop.

When the Left-Right swing function is activated, the  indicator appears.

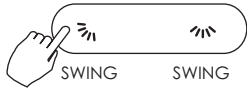

9. OPERATION

Up-Down airflow direction and swing (applicable products)



1. For every press of the SWING button, the louver changes in 6 degree increments.
2. Press and hold the button for 2 seconds to turn on the automatic SWING mode. Press the button again to stop the automatic SWING. When the automatic SWING function is activated, the  indicator appears.

- Please refer to the following instructions for products where the louvers can be operated individually.

1. Press the  button to activate the Up-Down louver function. The  indicator will flash.

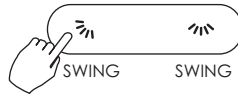



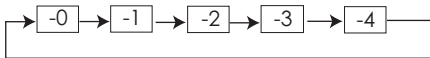

2. Pressing the "+" or "-" adjust buttons to select the adjustment of the four louvers. Each time you push the button, the wired control selects the louver in the following sequence. (The  icon denotes the four louvers move simultaneously.)



3. Use the  button to adjust the Up-Down direction of the selected louver.

10. TIMER FUNCTIONS

-  WEEKLY timer
Use this timer function to set operating times for each day of the week.
-  On timer
Use this timer function to start the system. The timer operates and the system starts after the set time has expired.
-  Off timer
Use this timer function to stop the system. The timer operates and the system stops after the set time has expired.
-  On and Off timer
Use this timer function to start and stop the system. The timer operates, and the system starts and stops after the set times have expired.

10. TIMER FUNCTIONS

To set the On or Off TIMER

1  Press the TIMER button to select the **Day^{On}** or **Day^{Off}**.

No display → **Week** → **Day^{On}** → **Day^{Off}** → **Day^{On}** / **Day^{Off}**

2  Press the CONFIRM button, the Clock display is flashing.

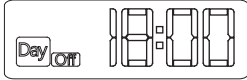
3  

Example: Off timer set at PM 6:00

Press the “+” or “-” adjust buttons to set the time. After the required time is set and confirmed, the timer is enabled.

4  Press the CONFIRM button again to complete the setting.

10. TIMER FUNCTIONS

To set the On and Off TIMER

1  Press the TIMER button to select the **Day^{On}** / **Day^{Off}**.

2  Press the CONFIRM button, the Clock display is flashing.

3  

Press the “+” or “-” adjust buttons to set the timer On time. Press the CONFIRM button to complete the setting.

4  Press the “+” or “-” adjust buttons to set the timer Off time.

5  Press the CONFIRM button to complete the setting.

11. WEEKLY TIMER

1 Weekly timer setting



Press the TIMER button to select the **Week**, press the CONFIRM button to confirm.

2 Day of the week setting

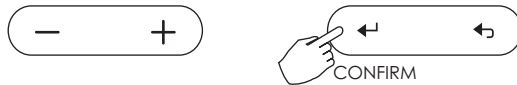

Press the "+" or "-" adjust buttons to select the day of the week. Press the CONFIRM button to confirm the setting.



3 ON timer setting of timer setting 1



Press the "+" or "-" adjust buttons to set the timer On time. Press the CONFIRM button to confirm the setting.

21

11. WEEKLY TIMER



Example: Tuesday time period 1

Up to 4 timer settings can be saved for each day of the week. This allows the user to configure the week timer to suit their lifestyle.

4 Off timer setting of timer period 1

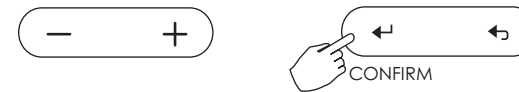

Press the "+" or "-" adjust buttons to set the timer Off time. Press the Confirm button to confirm the setting.



Example: Tuesday time period 1

5 Different timer settings can be set by repeating step 3 to 4.

6 Other days in the week can be set by repeating step 2 to 5.

NOTE: The weekly timer setting can be returned to the previous step by pressing the BACK button.

The time of timer setting can be deleted by pressing the DAY OFF button. The current setting will be restored and the system will exit the weekly timer setting automatically if there is no operation for 30 seconds.

22

11. WEEKLY TIMER

WEEKLY timer operation

To activate the WEEKLY TIMER operation



Press the TIMER button while **Week** is displayed on the screen.

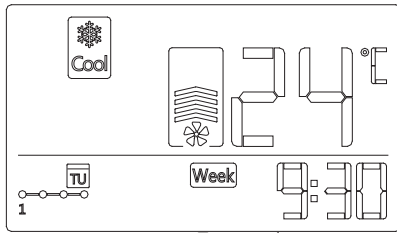

Example

To deactivate the WEEKLY TIMER operation



Press the TIMER button, the **Week** indicator will disappear.

• To turn off the system during weekly timer operation



1. Press the POWER button once quickly, and the system will turn off temporarily. The system will turn on automatically at the next set timer On time.

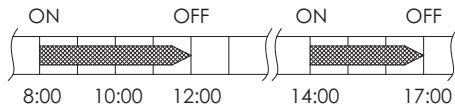

For example, if the POWER button is pressed once quickly at 10:00, the system will turn on again at the next set time of 14:00.

2. Press the POWER button for 2 seconds to turn the system off completely, this overrides the weekly timer function.

11. WEEKLY TIMER

To set the DAY OFF (for a holiday)

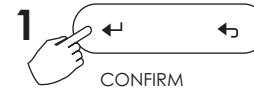

In weekly timer mode, press the CONFIRM button.

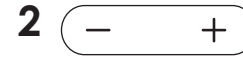

Press the "+" or "-" adjust buttons to select the day of the week.



Press the DAY OFF button to set the DAY OFF.



Example: The DAY OFF is set for Wednesday

4

The DAY OFF can be selected for other days by repeating steps 2 and 3.



Press the BACK button to go back to the weekly timer function.

To cancel: Follow the same procedures as those for setup

Note: The DAY OFF setting is cancelled automatically after the set day is passed.

11. WEEKLY TIMER

DELAY function



In the weekly timer function, press the DELAY button once, the display will read "0h". Press this button twice, the display will read "1h". Wait 3 seconds to confirm. This means the unit will override the settings for 1 hour. Press the delay button 3 times, the display will read "2h". Wait 3 seconds to confirm, the unit will now override for 2 hours.

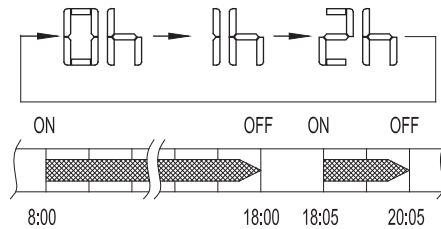

Example: Press the DELAY button to select "2h" at 18:05, and the unit will delay turning off for 2 hours, until 20:05.

Copy the setting from one day into another other day.

Settings made once can be copied into another day of the week. All of the settings of the selected day of the week will be copied. The copy function simplifies the programming functions and saves setting time.



1 In the weekly timer function, press the CONFIRM button.



2 Press the "+" or "-" adjust buttons to select the preset day to copy from.

11. WEEKLY TIMER



3 Press the COPY button, the letter "CY" will be displayed on the screen.



4 Press the "+" or "-" adjust buttons to select the day to copy to.



5 Press the COPY button to confirm.

The WE icon flashes quickly

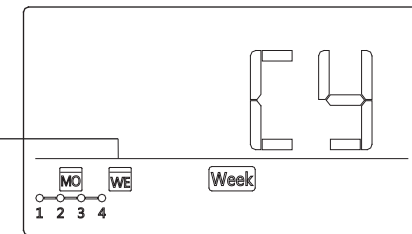

Example: Copy the setting of Monday to Wednesday

6 Other days can be copied by repeating step 4 and 5.



7 Press the Confirm button to confirm the settings.



8 Press the Back button to go back to the weekly timer function.

12. FAULT CODE DEFINITION

If the system does not operate correctly, the following faults may be evident. Investigate the system fault in accordance to the following fault codes.

NO.	FAULT CODE DESCRIPTION	FAULT CODE DISPLAYED
1	Communication error between wired control and indoor unit	F0
2	Power supply phase error	E0
3	Communication error between indoor unit and outdoor unit	E1
4	Sensor T1 fault	E2
5	Sensor T2A fault	E3
6	Sensor T2B fault	E4
7	Sensors T3/T4 fault, or compressor discharge sensor fault	E5
8	System anti-freeze protection	E6
9	EEPROM (electronic control) malfunction	E7

12. FAULT CODE DEFINITION

NO.	FAULT CODE DESCRIPTION	FAULT CODE DISPLAYED
10	Fan speed error	E8
11	Communication error between the main and sub board (display)	E9
12	Compressor current protection (four times)	EA
13	IPM malfunction	EB
14	Fresh Air malfunction	EC
15	Outdoor unit protection fault	ED
16	Water-level alarm and/or other malfunction	EE
17	Other malfunction	EF
18	Master control lockout	CP